

All profiles are shown in actual size.
 Product codes with an asterisk (ie: J123*) indicate at least one species that does not have a set-up charge.

WOOD MOLDING

Miscellaneous Molding

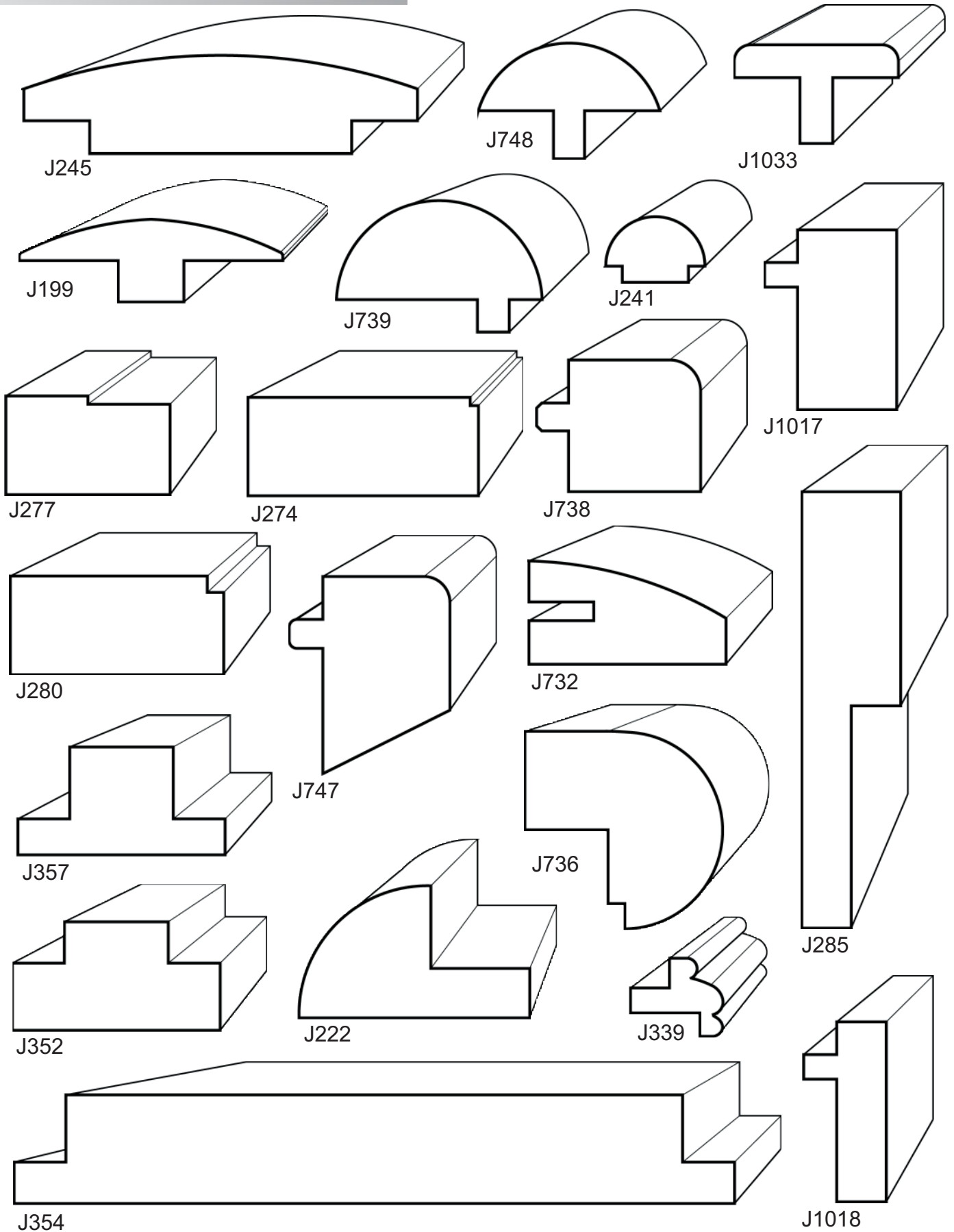

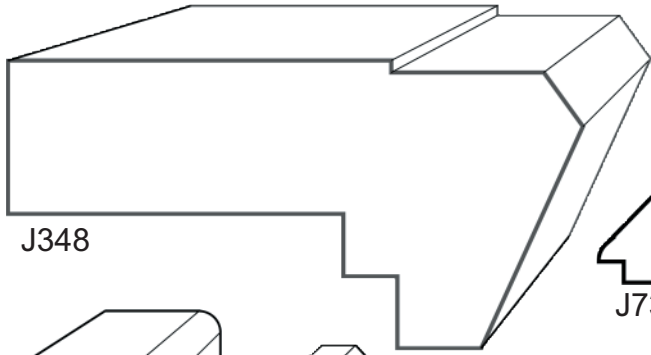

J348

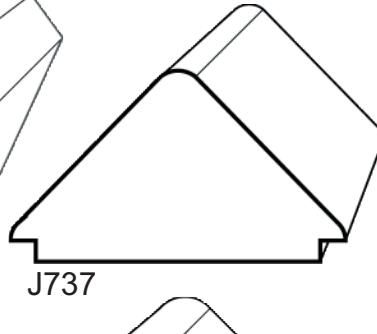

J737

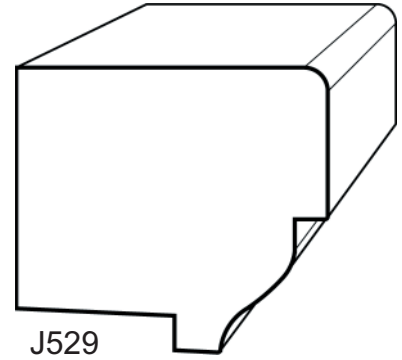

J529

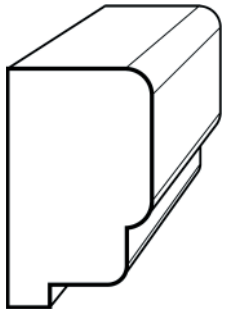

J140

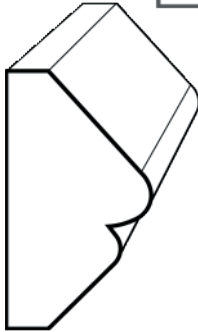

J868

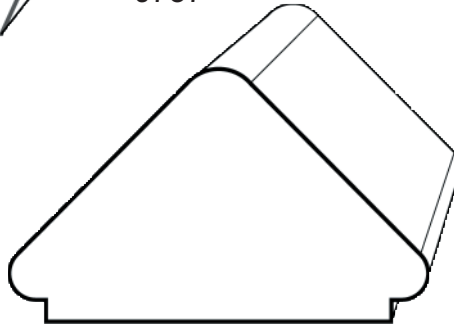

J734

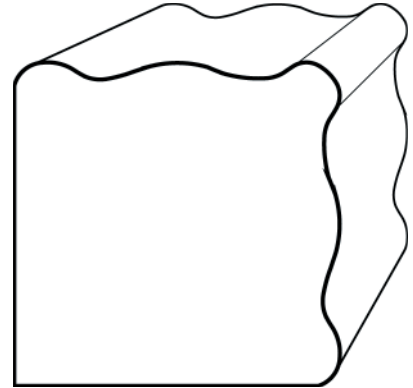

J265

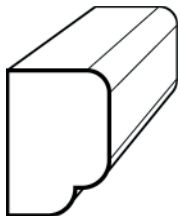

J519

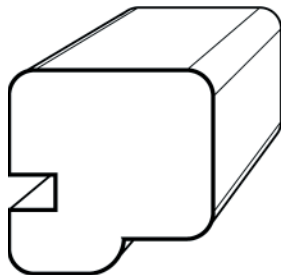

J182

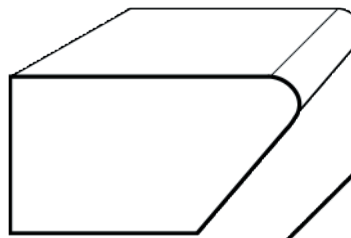

J238

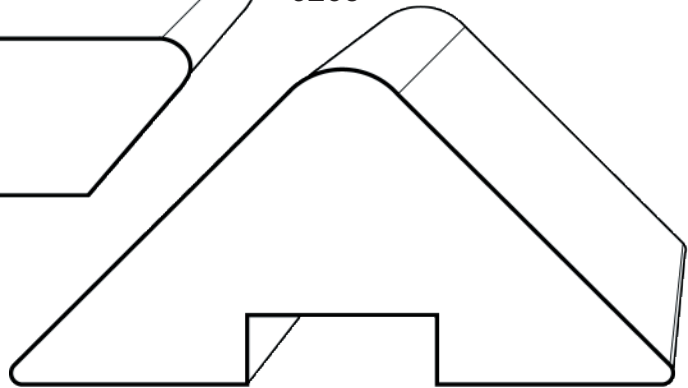

J242

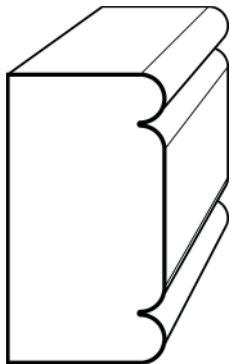

J030

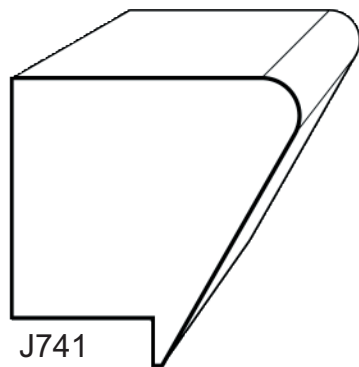

J741

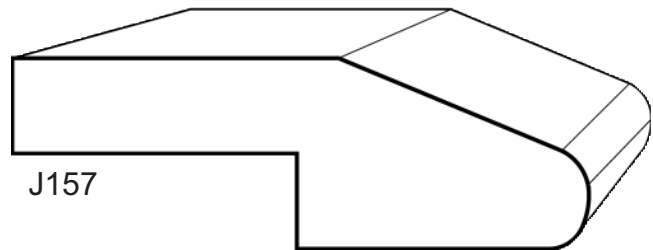

J157

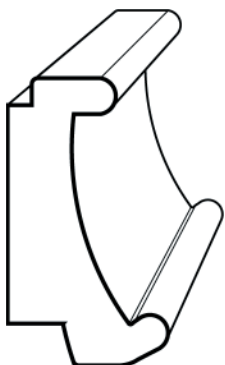

J040

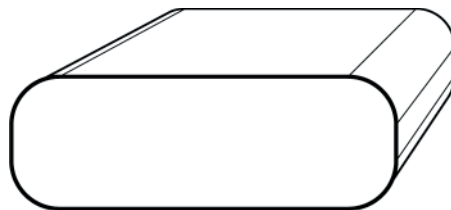

J262

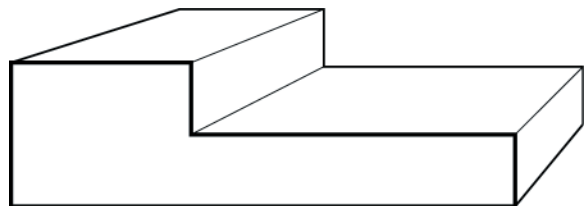

J263

WOOD MOLDING

Miscellaneous Molding



J296

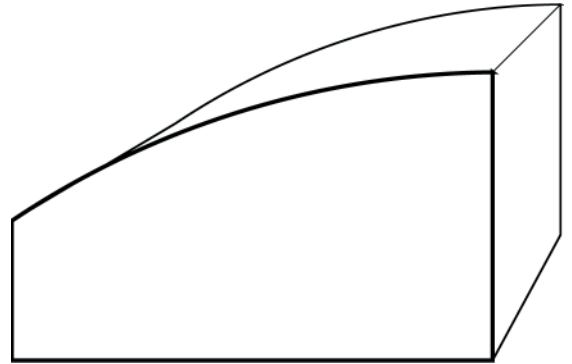

J231

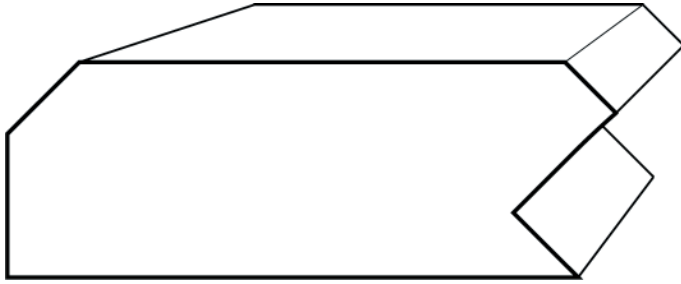

J250

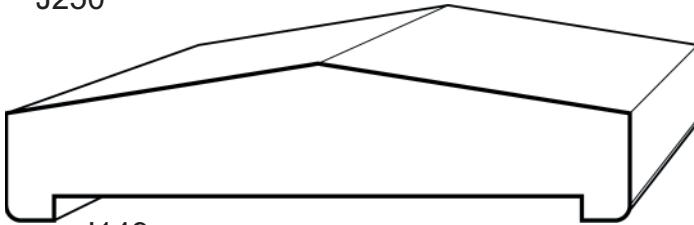

J149

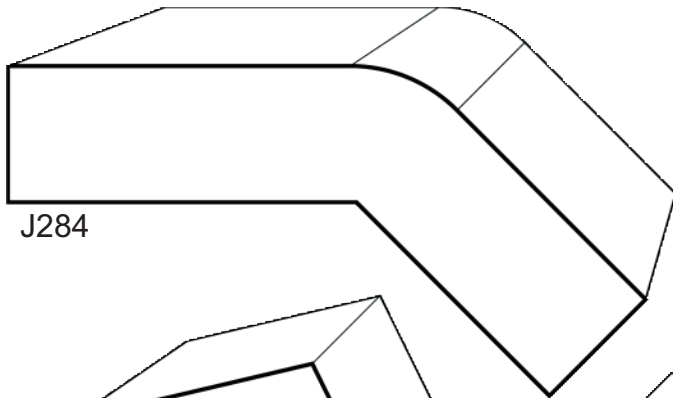

J284

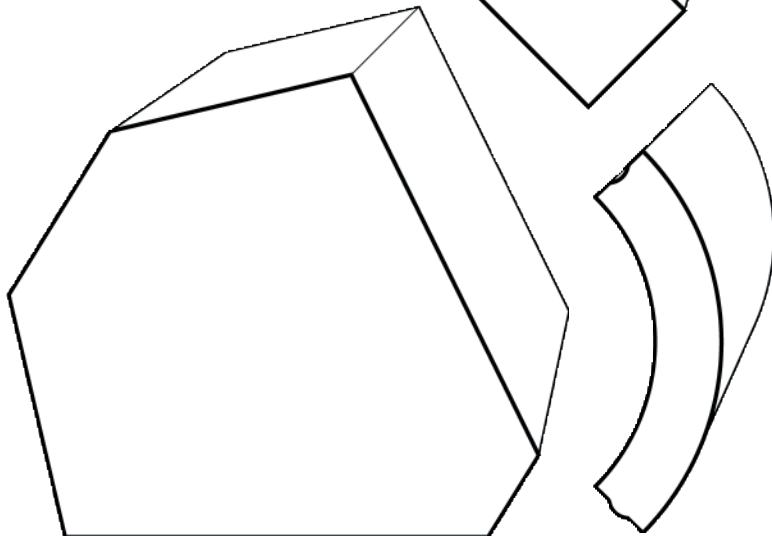

J195



J235

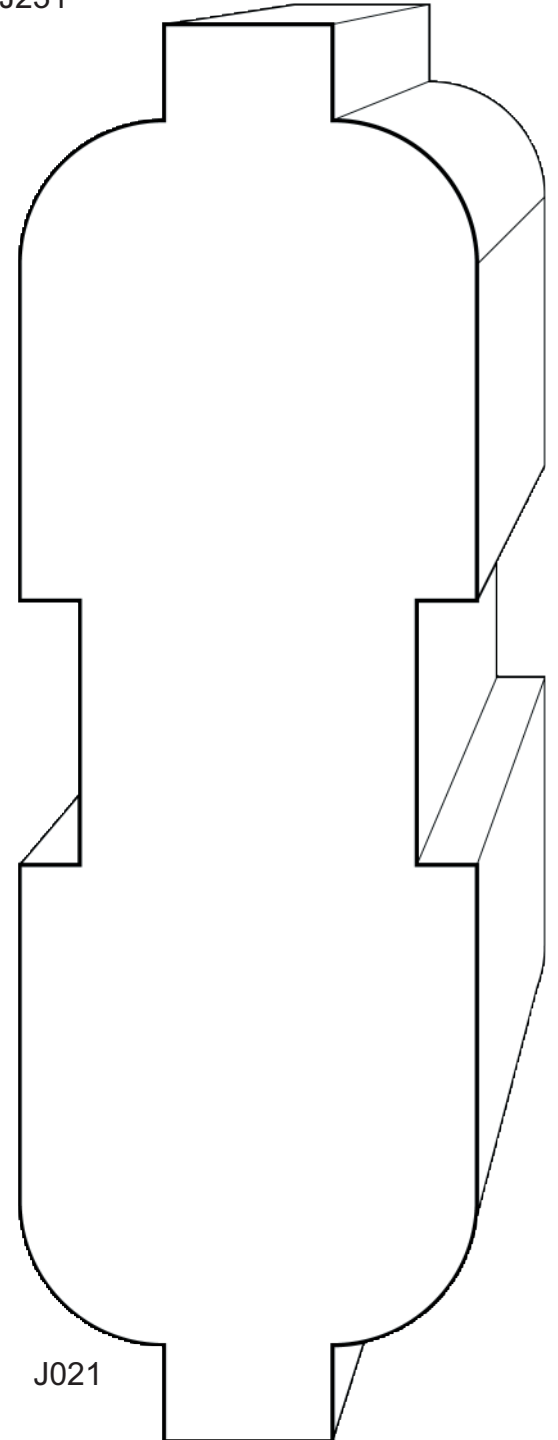

J021

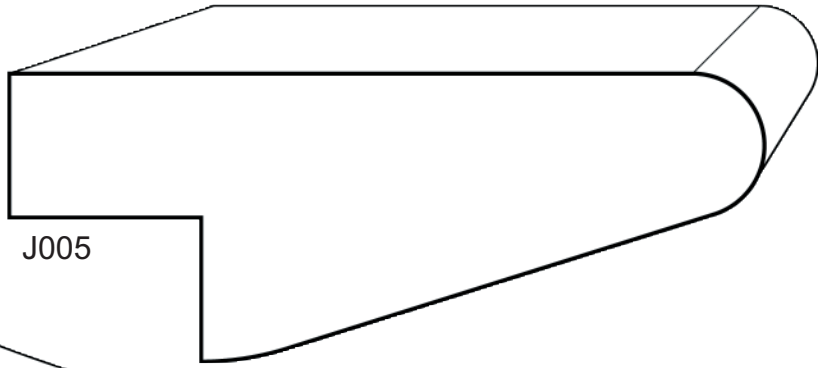

J005

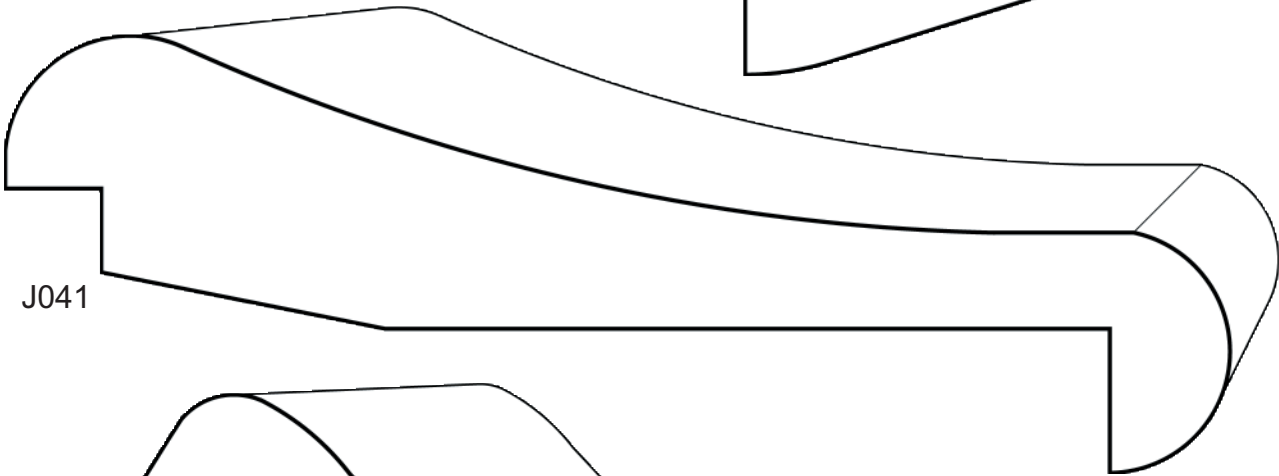

J041

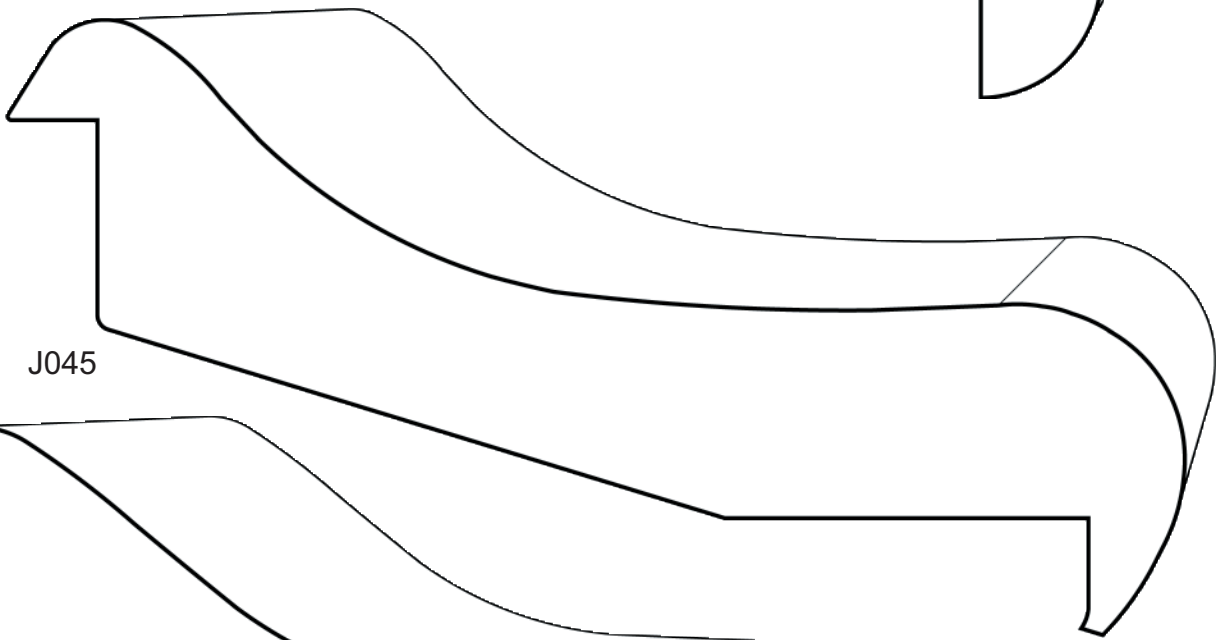

J045

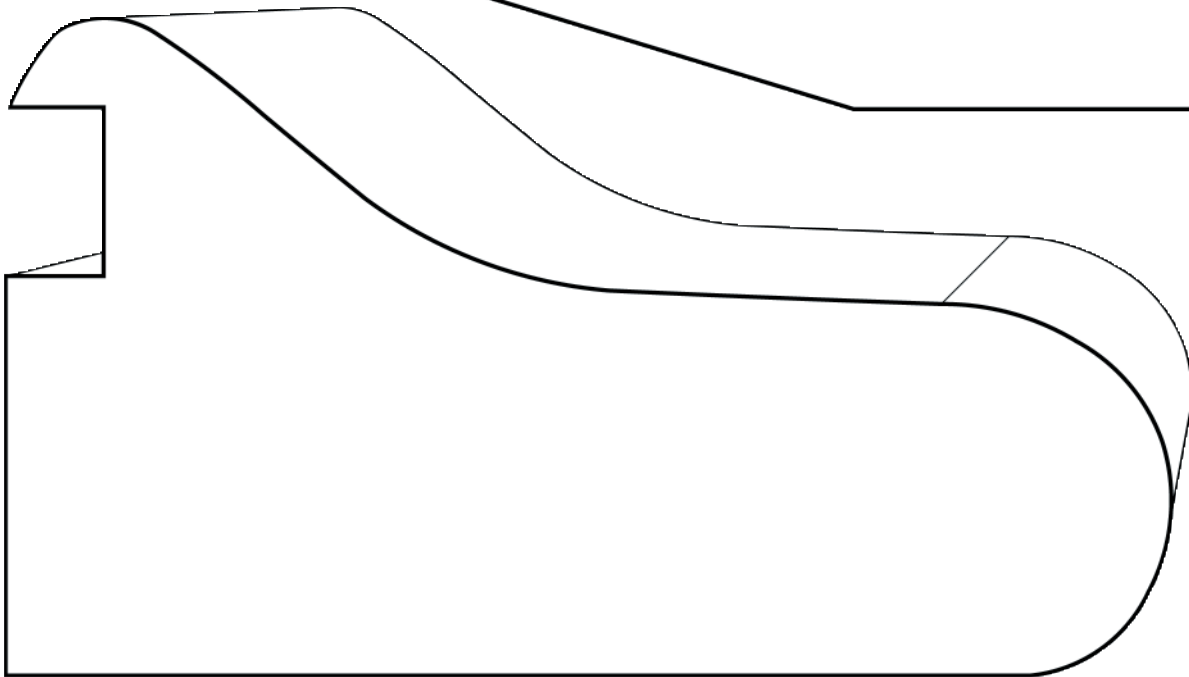

J949

All profiles are shown in actual size.
Product codes with an asterix (ie: J123*) indicate at least one species that does not have a set-up charge.

WOOD MOLDING

Miscellaneous Molding

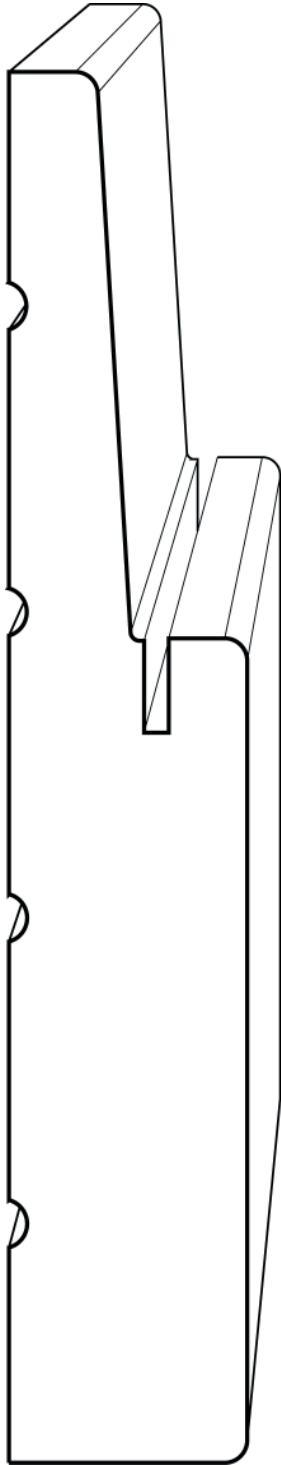

J756

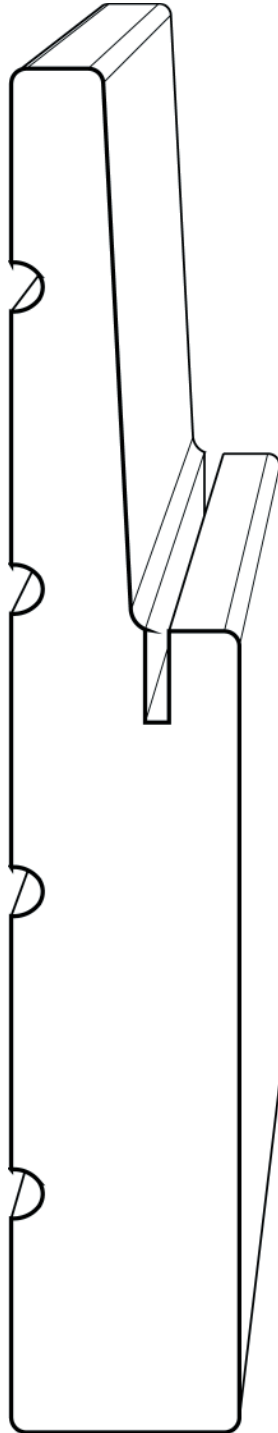

J145

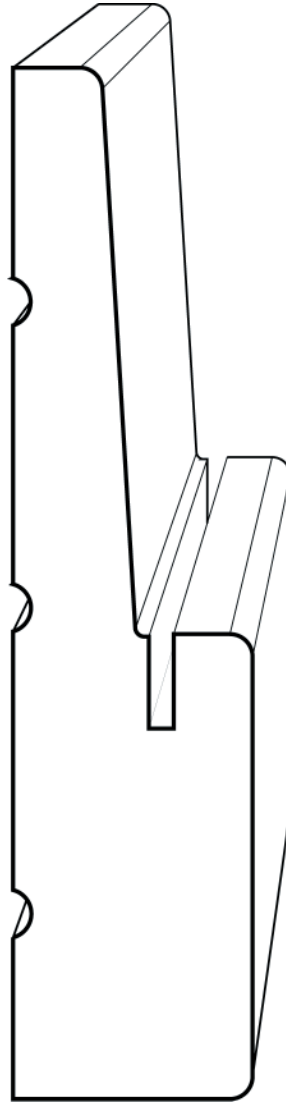

J755

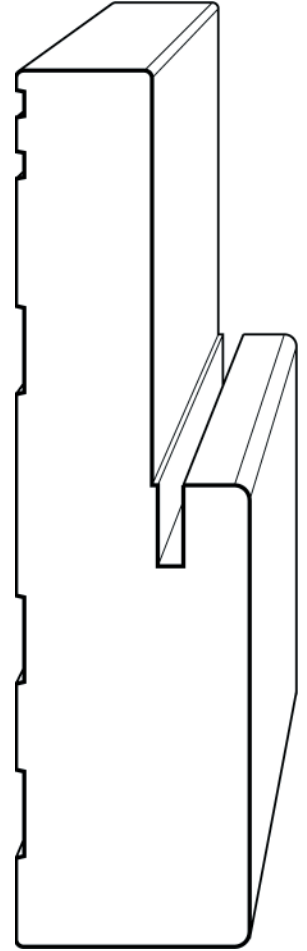

J147

Miscellaneous Molding

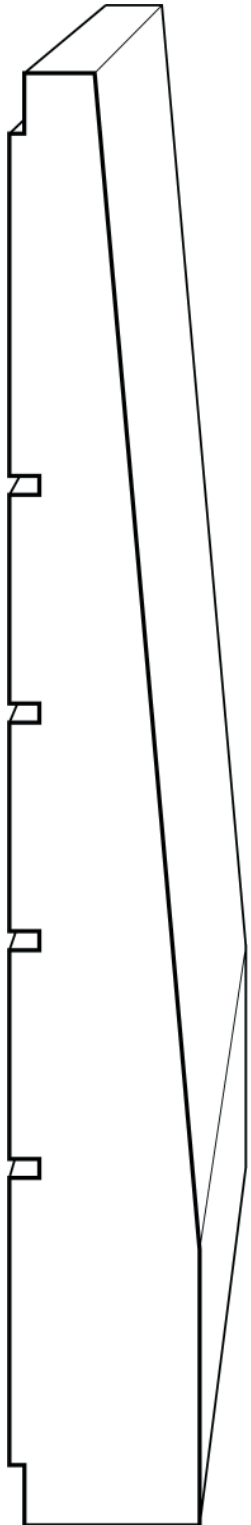

J758

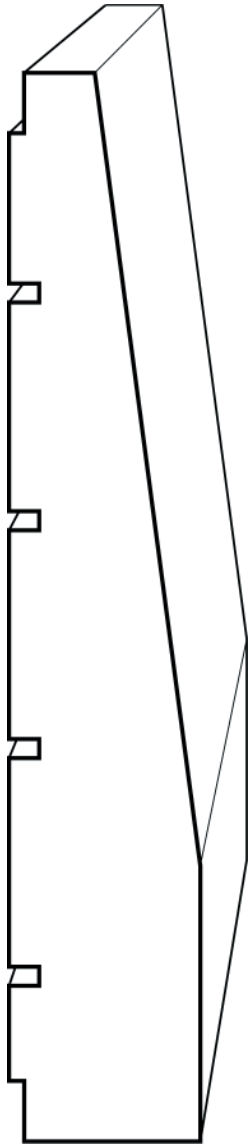

J757

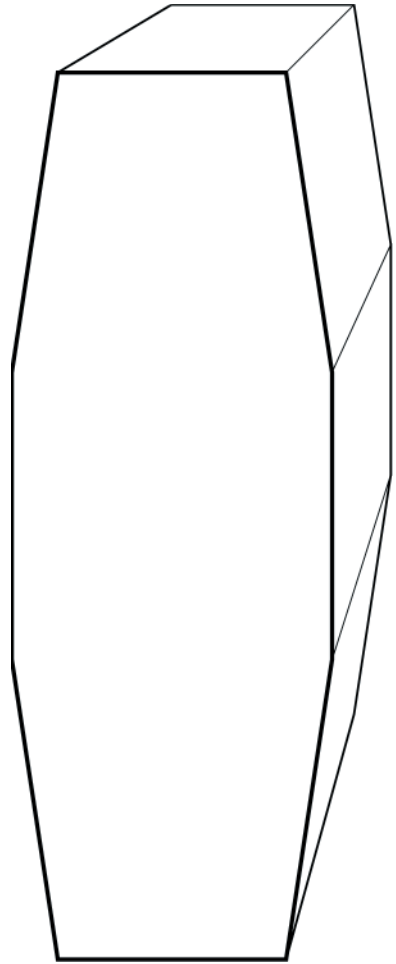

J1031