

WOOD MOLDING

Millwork and Furniture Molding

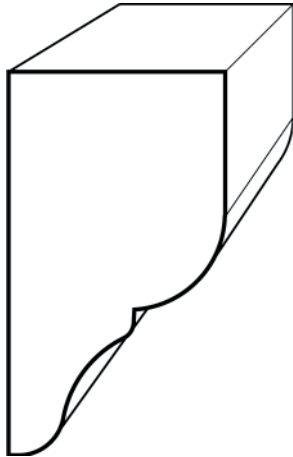

J823*

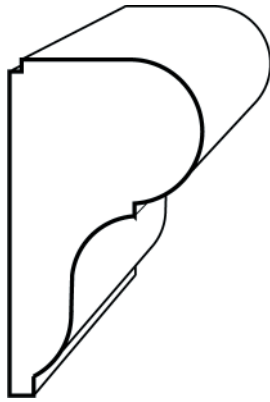

J270

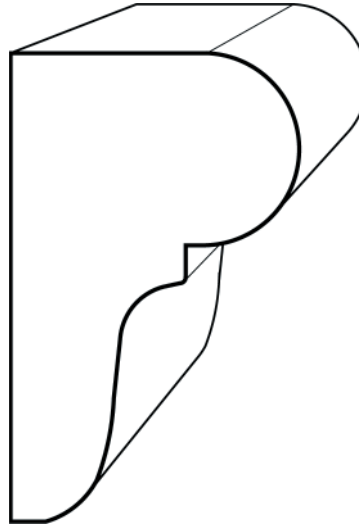

J287

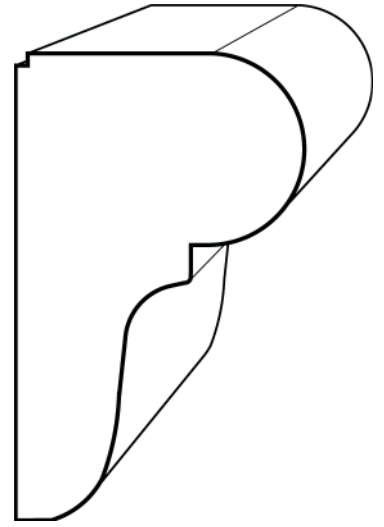

J266

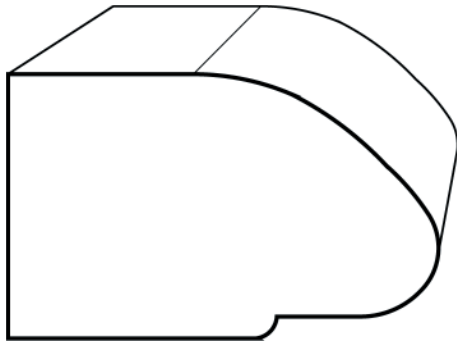

J948

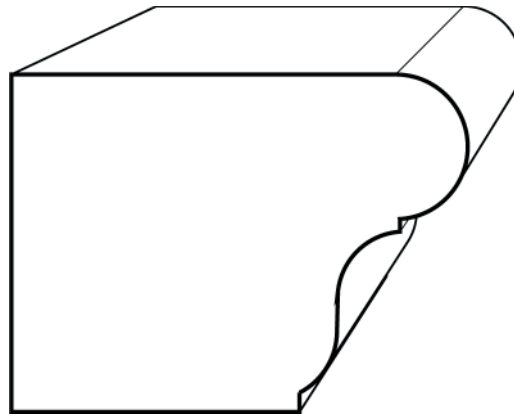

J267

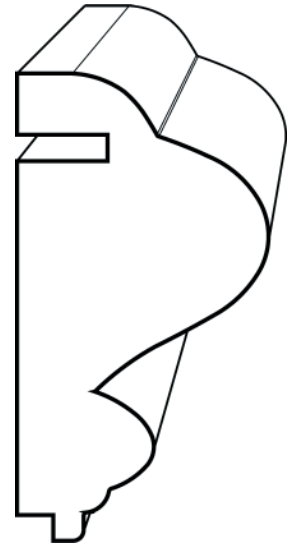

J830

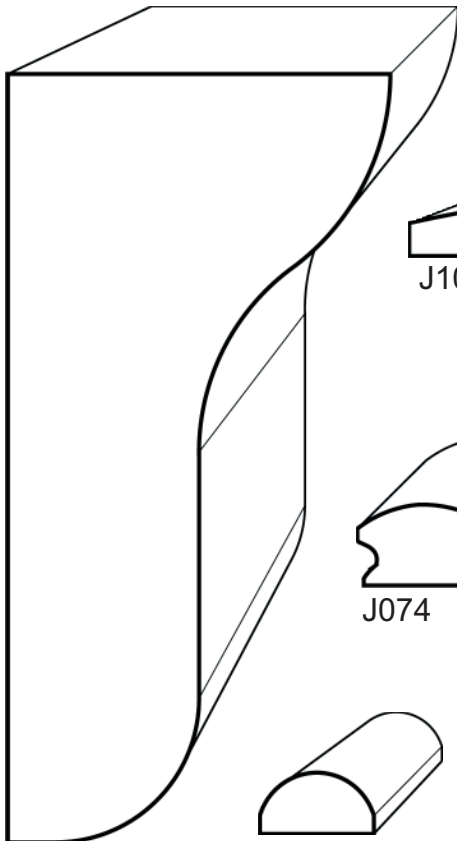

J380



J1003

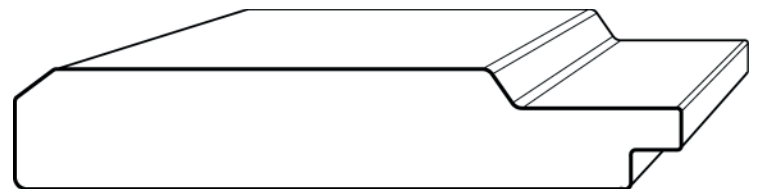

J006



J074

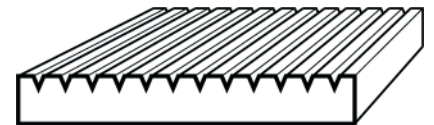

J385



J258

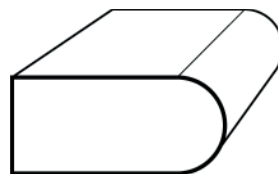

J191

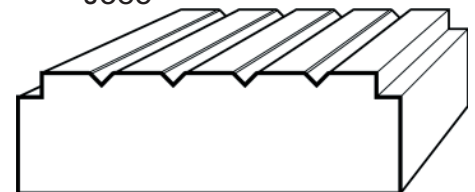

J386

Millwork and Furniture Molding



J824*



J526

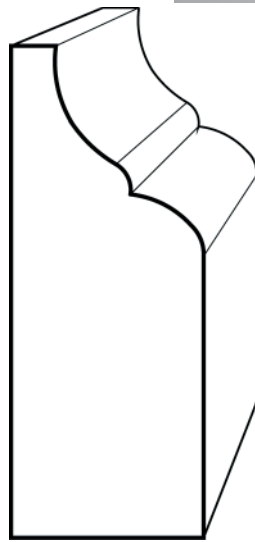

J635



J525

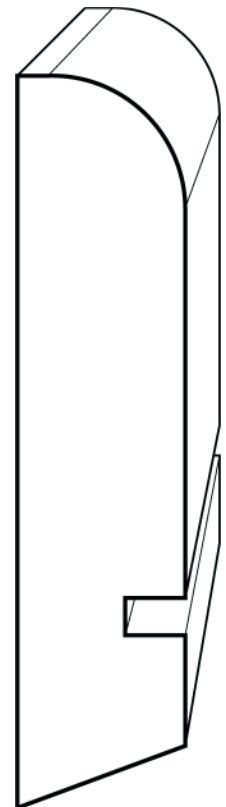

J036

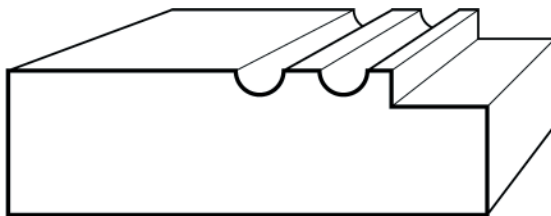

J742

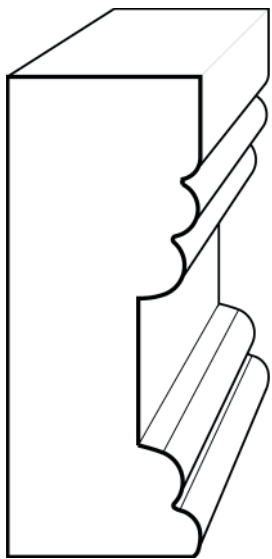

J168

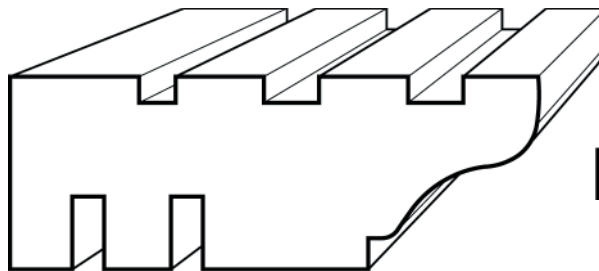

J744

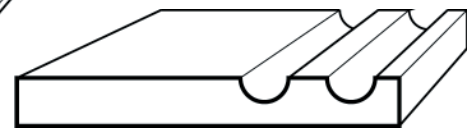

J743

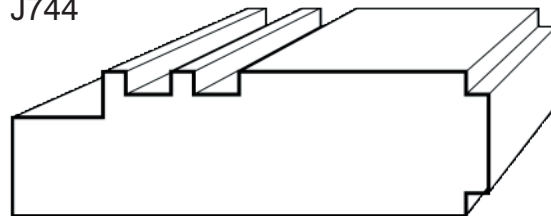

J1006

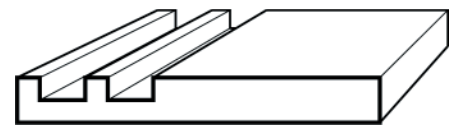

J1007

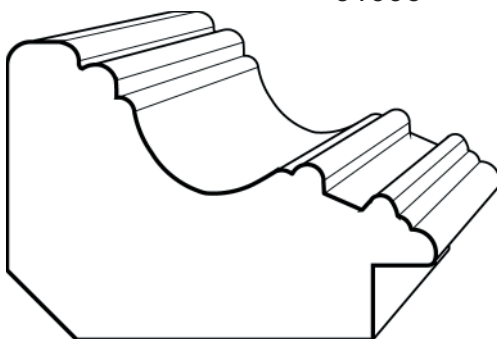

J351

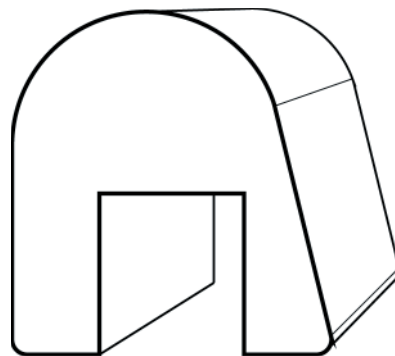

J911

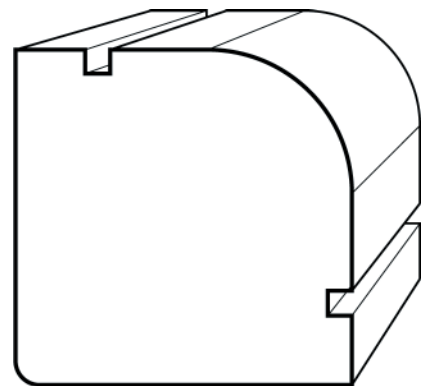

J237

All profiles are shown in actual size.
 Product codes with an asterisk (ie: J123*) indicate at least one species that does not have a set-up charge.

WOOD MOLDING

Millwork and Furniture Molding

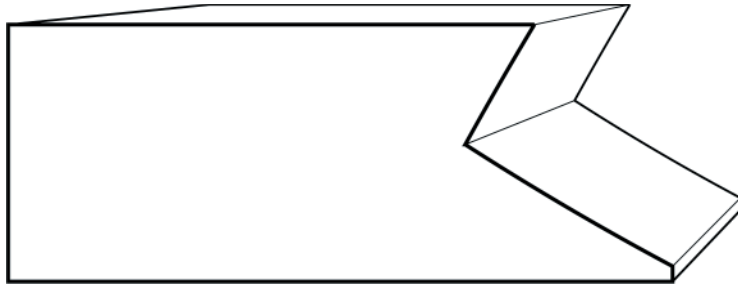

J043

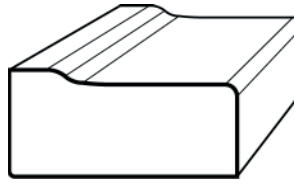

J080

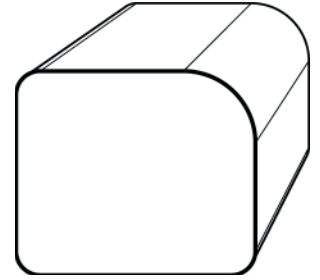

J369

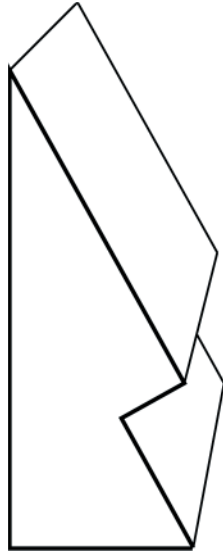

J362

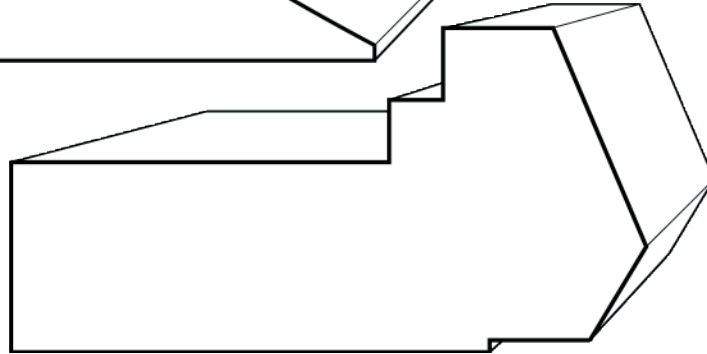

J960

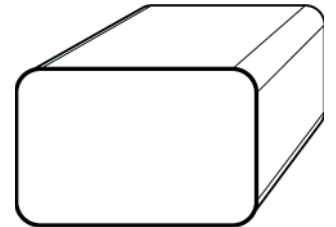

J367

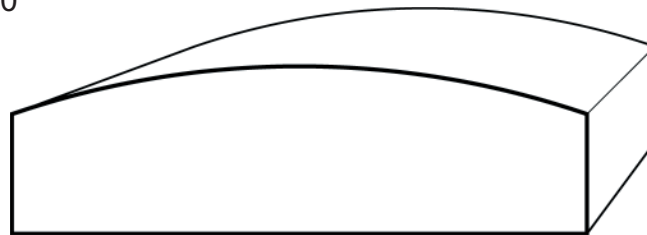

J179

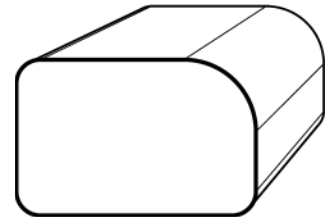

J368

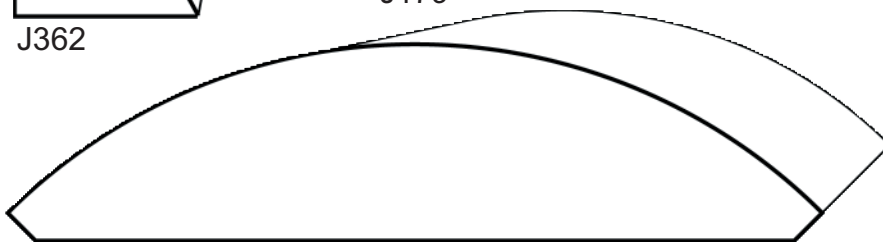

J1014

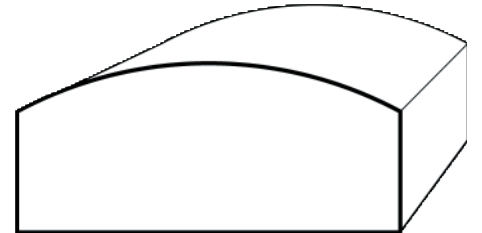

J180

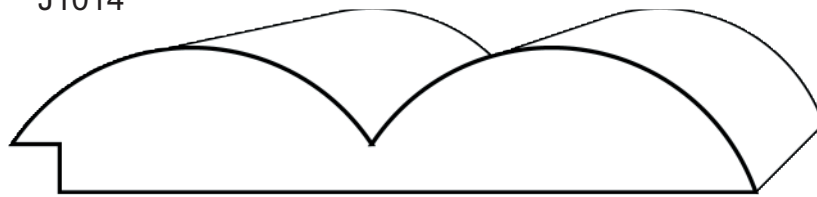

J1015

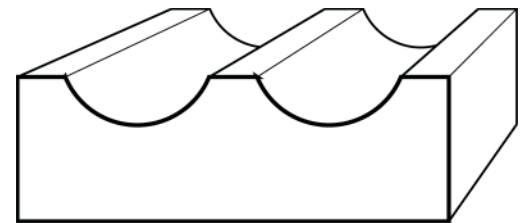

J1012

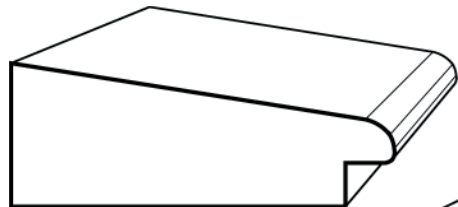

J159

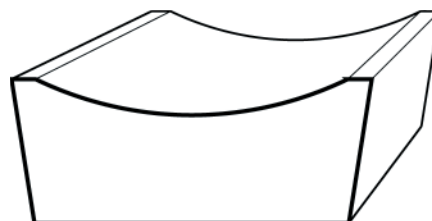

J086

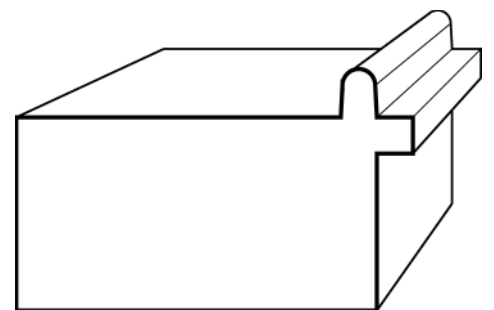

J062